

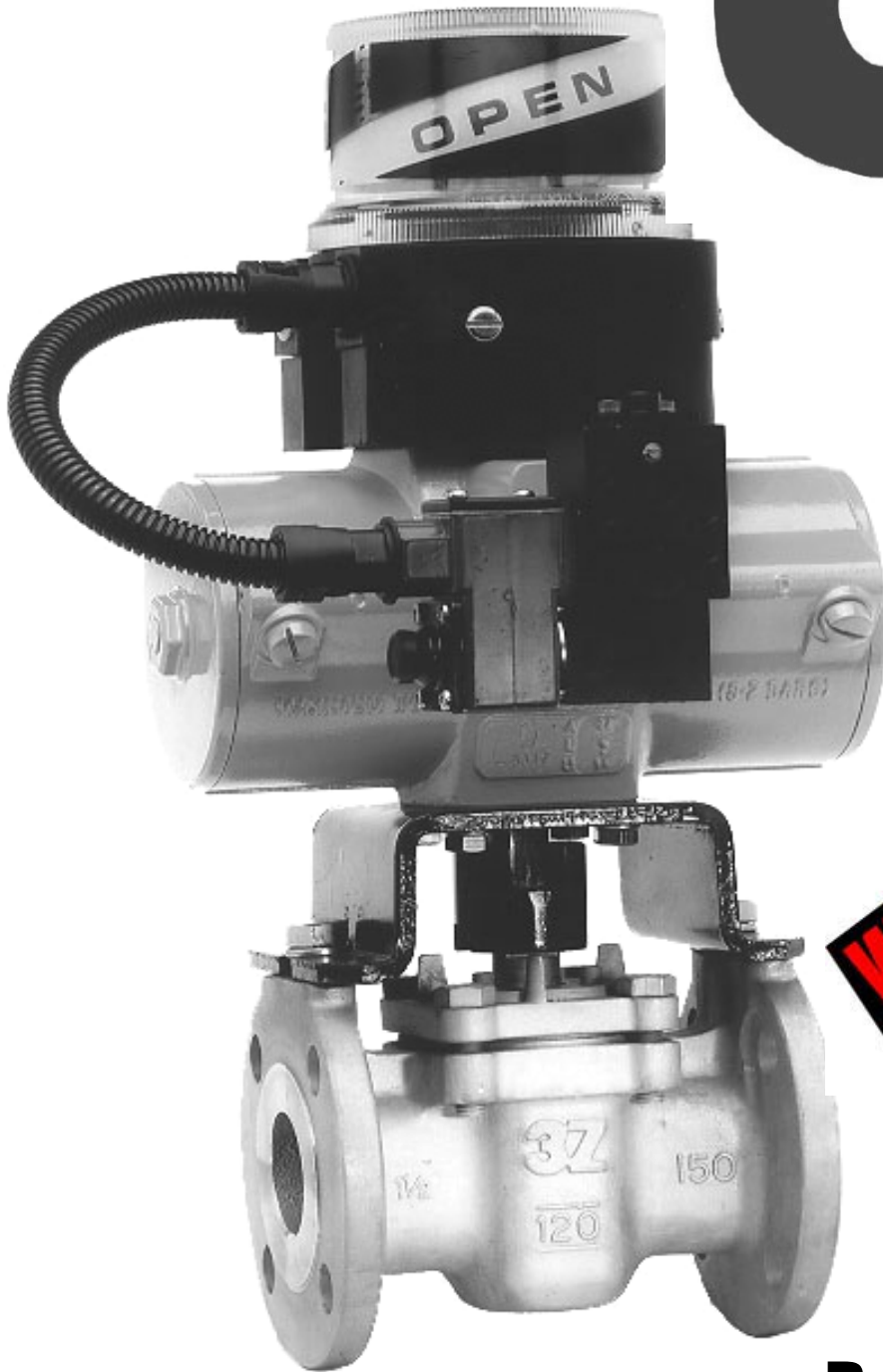

3Z

**The Solution
For The Valve
Problems**



**World
Best**

Product Summary

3Z[®] Plug Valves

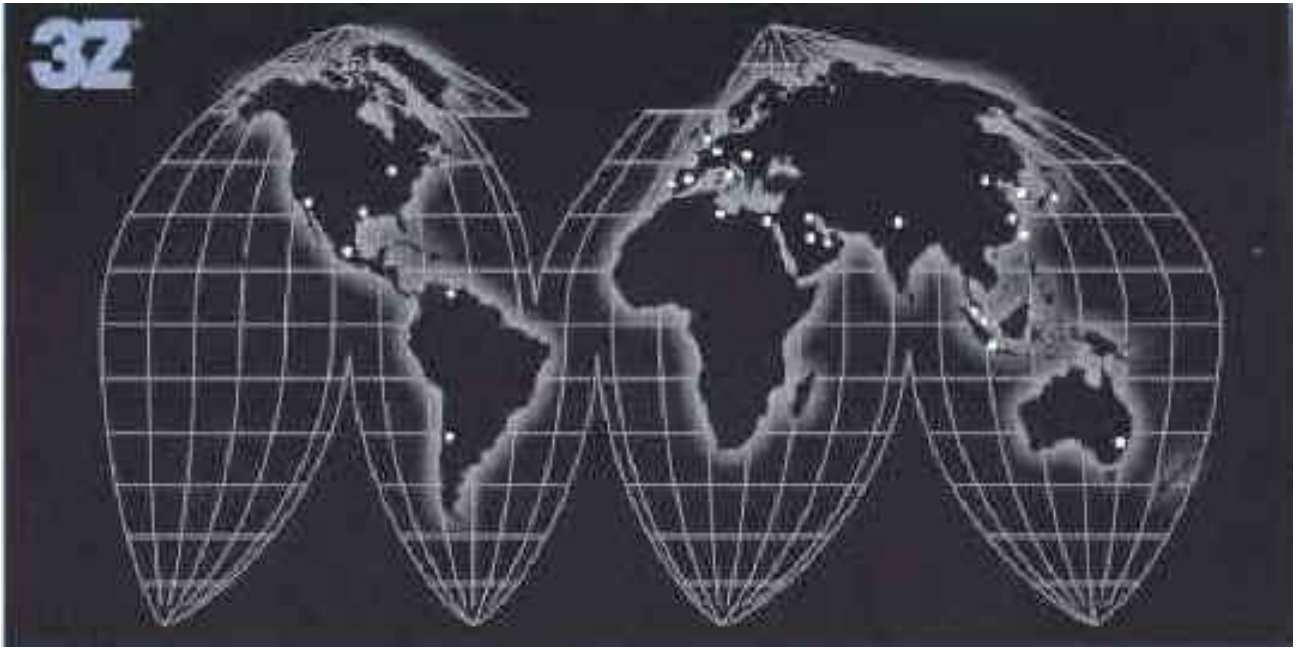

Worldwide Experiences

For over 12 years and across 40 countries, the 3Z valves have supplied and contributed to the outstanding performance for the processes of companies like Dow Chemical, Monsanto, Union Carbide, Exxon, Stamicarbon, Rhone-poulenc, Chiyoda, TOYO and more, Whether it is for a new constructions or MRO job, 3Z valves are there for the benefits of our customers.

Customer Satisfaction

Closely working and continuously communicating with our customers, the people at 3Z accommodate the customer's needs. Their concerns are reflected on the product design and services. Complicated valve problems have been resolved to our customers' satisfaction with the expertise of the 3Z people. For 3Z, the supreme quality, on-time delivery and competitive price are everyday targets that meet our customers' satisfaction.



Advanced Manufacturing

With modern technology in manufacturing, new facilities and a directly owned alloy foundry, 3Z is able to provide high quality, yet economical manufacturing. 3Z provides our customers with the most competitive prices. As a manufacturing center for 3Z valves, the newest Korean manufacturing facility is coupled with high grade expertise and state of the art technology.



Complete Line of Products

Non-lubricated design of metal seated, Teflon sleeved, Teflon lined and even lubricated design of metal seated plug valves, we have them all to better serve our customers. The range of wider and deeper products helps the customer to resolve valve problems in one stop. Utilize our expertise for your benefits! We are glad to be at your service.



3Z Sleeved Products

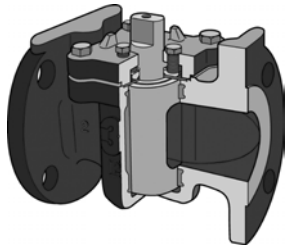

**3Z Sleeved
Plug Valve**



**3Z Standard
Port Plug Valve**
FIG 120, 320, 620

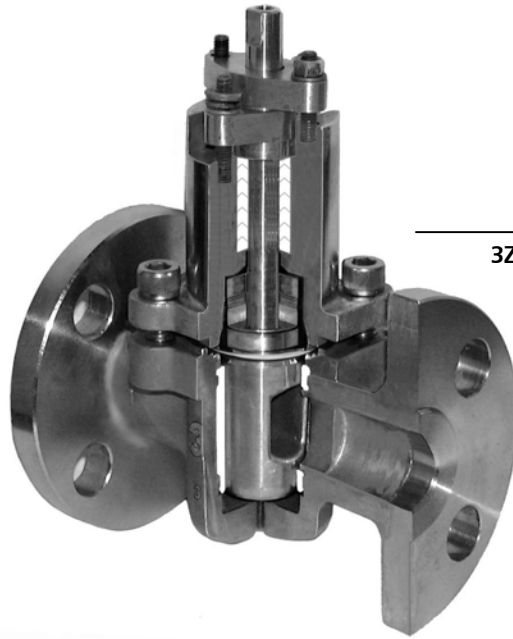

3Z Live Loaded Plug Valve
FIG 120LL, 320LL, 620LL



**3Z Full Port
Plug Valve**
FIG 120FB, 320FB, 620FB



**3Z 3-Way
Plug Valve**
FIG 130, 330, 630



**3Z Gear Operated
Plug Valve**
FIG 120G, 320G, 620G



**3Z Jacketed
Plug Valve,
Full or Partial**
FIG 120FJ, 320FJ, 620FJ, 120PJ, 320PJ, 620PJ

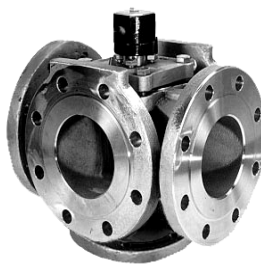

**3Z 5-Way
Plug Valve**
FIG 150, 350, 650



**3Z Screwed End
Plug Valve**
FIG 122SE, 322SE, 622SE



**3Z 3-Way Full
Port Plug Valve**
FIG 130FB, 330FB, 630FB

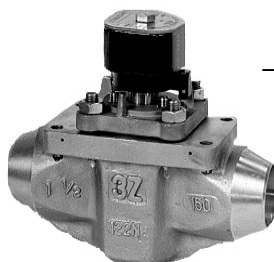

**3Z Nuclear
Plug Valve**
FIG 122N BW, 322NBW, 622N BW



**3Z Socket
Welded End
Plug Valve**
FIG 122SW, 322SW, 622SW

Fully Lined Products

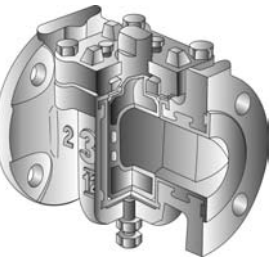

3Z Lined Plug Valve



3Z Bottomless Plug Valve
FIG 121, 321



3Z 2-way Lined Plug Valve
FIG 121, 321



3Z Lined Ball Check Valve
FIG 171, 371



3Z Lined Live Loaded Plug Valve
FIG 121LL, 331LL



3Z Lined Swing Check Valve
FIG 181, 381, 681



3Z 3 way Lined Plug Valve
FIG 131, 331



3Z Lined Y-Type Strainer
FIG 191Y



3Z 5-way Lined Plug Valve
FIG 151, 351



3Z Lined Strainer
FIG 190

Metal Seated, Non-Lubricated

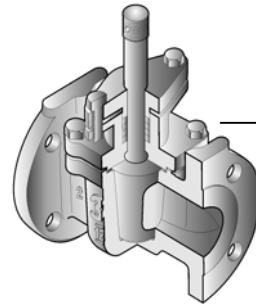

3Z Metal Seated Plug Valve Non-Lubricated



3Z Metal Seated Plug Valve, Non-Lubricated
FIG 123, 323, 623



3Z Metal Seated Plug Valve, Non-Lubricated & Jacketed
FIG 123PJ, 323PJ, 623PJ



3Z Metal Seated Plug Valve, Non-Lubricated 4-Way Type
FIG 143, 343, 643



3Z Metal Seated Plug Valve, Non-Lubricated Wedge Type
FIG 123W

Metal Seated, Lubricated

PRESSURE BALANCED TYPE

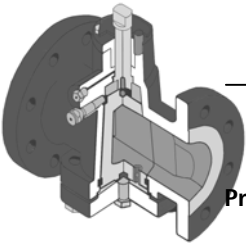

3Z Metal Seated Plug Valve Lubricated & Pressure Balanced.



3Z Metal Seated Plug Valve, Lubricated & Pressure Balanced.
FIG 125, 325, 625, 925, 1525



3Z Metal Seated Plug Valve, Lubricated & Jacketed.
FIG 125 FJ, 325 FJ, 625 FJ, 925 FJ, 1525 FJ, 125 PJ, 325 PJ, 625 PJ, 925 PJ, 1525 PJ

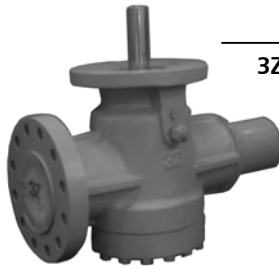

3Z Metal Seated Plug Valve, Lubricated RF/BW

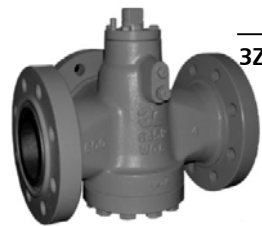

3Z Metal Seated Plug Valve, Lubricated, 3-Way Type.
FIG 135, 335, 635, 1535

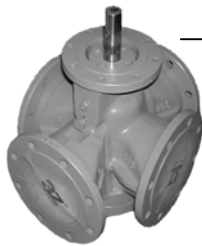

3Z Metal Seated Plug Valve, Lubricated, 4-Way Type.
FIG 145, 345, 645, 945, 1545

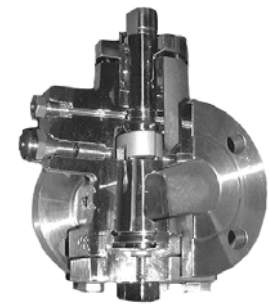

Metal Seated Plug Valve, Lubricated, RF
FIG 125, 325, 625, 1525



3Z Metal Seated Plug Valve, Lubricated, Full Bore Type
FIG 125FB, 325FB, 625FB, 925FB, 1525FB

Double Block & Bleed Products

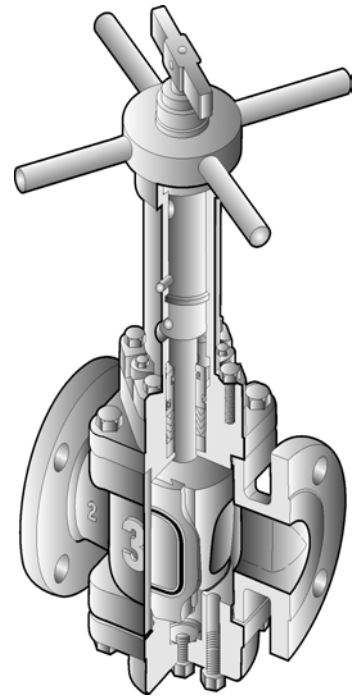

3Z Double Block & Bleed Plug Valve, Non-Lubricated,



3Z Double Block & Bleed Plug Valve, Non-Lubricated,
FIG 1524

TOP ENTRY TYPE

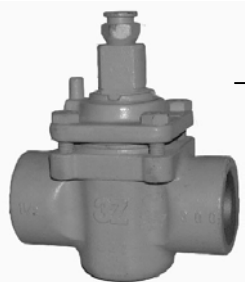

3Z Metal Seated Plug Valve, Lubricated,
FIG 125SE, 325SE

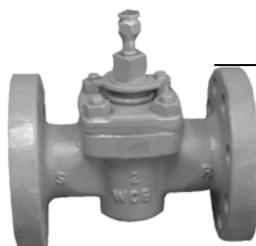

3Z Metal Seated Plug Valve, Lubricated, RF
FIG 125, 325,

Eccentric Products

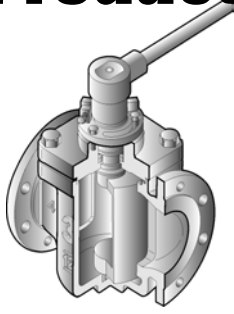

3Z Eccentric Plug Valve, Non-Lubricated



3Z Eccentric Plug Valve, Non-Lubricated
FIG 126,326,626



3Z Eccentric Plug Valve, Non-Lubricated Metal Seated
FIG 126,326,626



3Z Eccentric Plug Valve, Non-Lubricated Rubber Coated
FIG 126,326,626

Specialty Products

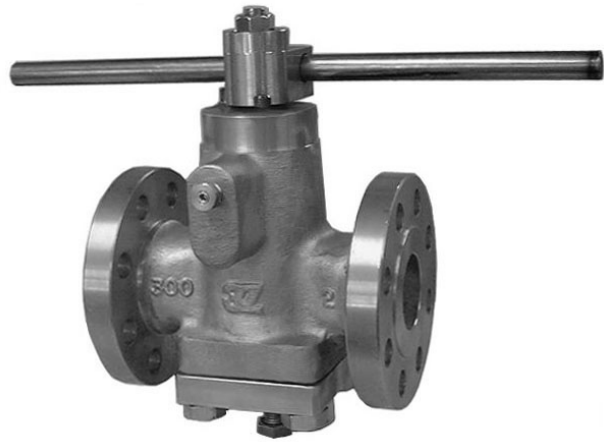

3Z Severe Service valve
FIG 120 SS

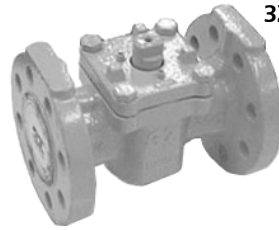

3Z Hydrofluoric Acid Service Valve Port Plug Valve
FIG 120HF, 320HF, 620HF



3Z Chroline Plug Valve
FIG 120CL,320CL,620CL



3Z Caged Plug valve
FIG 120 CG 320CG,620CG

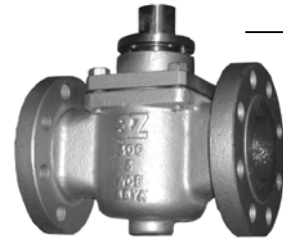

3Z Trunion Mounted Plug Valve
FIG 620



3Z Bleed Systems Valve
FIG 120DBB, 320DBB, 620DBB



3Z Tandem Valve
FIG 120 ,320,620

In order to find the detail information, please send us either e mail or visit web site as follows:

e-mail:3z@3zvalve.com
www.3ZVALVE.com

- 3Z Autoclave Line Plug Valve
- 3Z Black Liquor Line Plug Valve
- 3Z Cryogenic Plug Valve
- 3Z Chlorine Valve
- 3Z Diverted Type Plug Valve
- 3Z Fingertrol Plug Valve
- 3Z Fire Safe Plug Valve
- 3Z Gas Distribution Plug Valve
- 3Z Hydrofluoric Acid Service Valve

- 3Z Metal Proving Plug Valve
- 3Z Piloted Plug Valve
- 3Z Power Plant Plug Valve
- 3Z Spandex Plug Valve
- 3Z System Flush Plug Valve
- 3Z Tandem Plug Valve
- 3Z Underground Plug Valve
- 3Z Vacuum Plug Valve

Process Control Products



3Z Electric Control
Plug Valve
FIG 120CVE

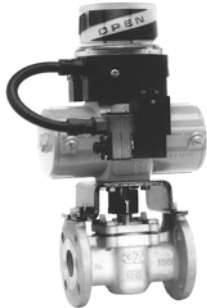

3Z Direct Mounted Pneumatic
Control Plug Valve
FIG 120CVD



3Z Spring Return type
Pneumatic Control valve
FIG 120CV



3Z Pneumatic Interlocked
Type Plug Valve
FIG 120CVT



3Z Heavy Duty Spring
Return Type
Plug Valve
FIG 120HD

Applications

- Oil & Gas (Upstream)
 - Petroleum Base : Oil Drilling, Transportation, Pipe Lines,
 - Gas Base : Natural Gas (Wells, Drilling, Transportation),
- Petrochemicals (Downstream)
 - Petroleum Base : Refining ,Storage, Distribution
 - Lubricating oils , Grease plants
 - Gas Base: Processing storage, Distribution, Plastics, Resins, Latex : LDPE, LLDPE, HDPE, PC, PVC, PVA, ABS, SAN, Phenolics, PP, PS, PE, PU, Amino, Acrylics, Cellopane, Coumarone Indene, Epoxies, Cellulosics, Rosin Mods, etc.
 - Man-Made Fibers : Cellulosics (Rayon, Acetates), Synthetics (Acrylics, Aramid, Fluorocarbon, Polyester, Nylon, Acrylics, Polyolefins, Saran, Spandex, Vinyon, etc.)
 - Agrochemicals : Pesticides (Herbicides, Insecticides, Fungicides), Fertilizers (Ammonia, Ammonium Nitrate/Sulfate /Phosphates, Urea, etc.)
 - Synthetic Rubbers (Elastomers) : SBR, Butadiene, Isoprene, Neoprene, Butyl, EPDM, Nitrile, Urethane, Silicone, etc.
 - Cyclic Organic Intermediates : Paints, Dyestuffs, Pigments (Toners, Lakes)
 - Organic, Inorganic & Industrial Gases : Acetaldehyde, Acetic Acid, Acetone, Acetone, Acetylene, Acrylamid, ANM, Adipic Acid, BTX, Caprolactam, Chlorine, Cumene, EDC, Ethylene, EO, EG, H₂O₂, MA, Melamine, MDI, Nitric Acid, Oleum, Oxgen, Phenol, Phosgene, LPG, PO, PG, NaCl, SM, S, H₂SO₄, TPA, Toluene, TDI, VA, VCM, etc.
 - Fine Chemicals, Basics & Intermediates, Fatty acids, Gum and Wood Chemicals, Detergents & Soaps, Explosives, Adhesives, Sealants, Surfactants, Varnishes, Solvents, Plasticizers, etc.
 - Coal, Shale & Tar Sand Base : Processing, Tar Crudes, Gasification, Gas Distribution, Coal Chemicals, Cokes By-products
- Conventional Chemical Plants
- Chloro-Alkali Plants, Electrolysis Chemical Plants, etc.
- Power Plants - Nuclear, Fossil
- Steel Mills & Products Plants
- Metal Mining & Refining Plants. : Copper, Aluminum, Zinc, etc.
- Pulp & Paper Plants : Black Liquor, Green Liquor, Bleaching
- Pharmaceutical Plants
- Water Treatment Plants : Waste, Portable, Process, etc.
- Utilities Media Handling : Steam, Fuel Oil & Gases, Air, etc.